

Thank you for selecting Clean products.
Before using the tester, relevant person must read and understand the contents of this operation manual. Operation Manual should be kept accessible within the person who use the testers.

TABLE OF CONTENTS

1. Product Overview	2
2. Precautions	3
3. CONFIGURATION and LCD INTRODUCTION	3
4. Key Panel	4
5. Battery and electrode installation	4
6. Measurement Mode	5
7. Calibration Mode	5
8. Set up	6
9. Parameters	7
10. Package	7
11. Error	8
12. GENERAL INFORMATION	8



1. Product Overview

- Precise and easy operation, Comfortable holding, all functions operated in one hand.
- Large LCD with backlight, Multi-line display for easy reading, Auto-Power Off saves battery after 5 mins non-use.
- 1 * 1.5V AAA long battery life.
- Floats on water, IP67 rated.
- Field throw measurement(Auto Lock Function)
- Broad measuring range: 0.0 μS/cm -20.00mS/cm,from pure water to waste water applications.



Floats on water
IP67 rated



Large LCD with
backlight
Multi-line display
for easy reading



Field throw
measurement
(Auto Lock Function)



1*1.5V AAA
long battery life

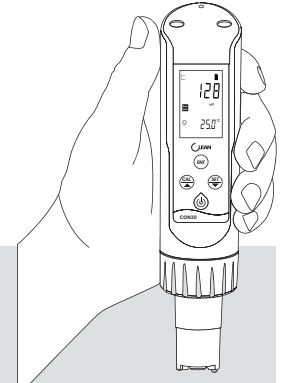

www.cleaninst.com
E-mail: CS@cleaninst.com
021-63531465



2. Precautions

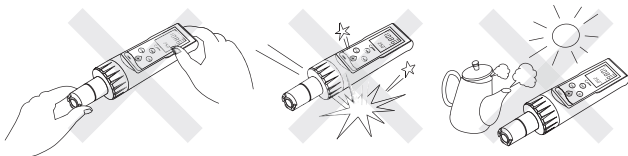

Please wipe up the electrode with clean tissue or cloth before using.

Do not throw or beat, squash or twist the tester deliberately.

Do not expose to the direct sunlight or put in high humidity or high temperature environment .

Do not use for long time under water.



3. CONFIGURATION and LCD INTRODUCTION

- ⚙️ Set up
- ⏱️ Data stabilized
- 🔧 Calibration Mode
- 🔋 Low battery indicator
- 📏 Measurement mode
- 🔒 Auto Lock function
- 🔒 Auto Lock after data stabilized
- 📏 In calibration
- 😊 Sensor slope is above 85%
- 😐 Sensor slope is between 70%-85%

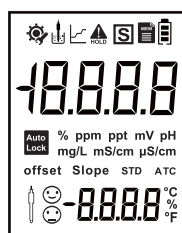

4. Key panel

Key instruction

Short press: Short press means release the key once after pressing.
(If there is no mark out below, default it as Short press)

Long press: Long press means press the key for 3 seconds and then release it

Hold: Hold means not release the key and accelerate after a certain time. Not release the key until the value is set as needed.

	Long press to Power ON/OFF Short press to ON/OFF backlight Escape key when in calibration mode and setting up
	Calibration key when in measurement mode Long press to enter into parameter browsing Increment values or scroll through the next options available
	Data setting Decrement values or scroll through the next options available
	Confirm key Press to unlock in Auto lock mode

5. Battery and Electrode installation

Unscrew the screw cap by following the arrow direction, slightly unplug the electrode, install the battery (pay attention to the anode and cathode of the electrode).

Then install back the electrode and the screw cap.

Low battery prompt is at the top of the screen when battery power is low. (You can refer to the LCD INTRODUCTION). Please change the same model battery.

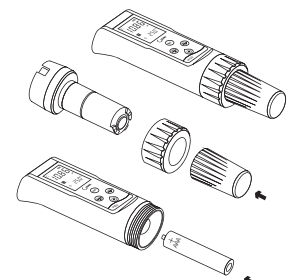

6. Measurement Mode

Press "⏻" to power up. The tester will then enter into measurement mode. The measurement icon will twinkle if the data is unstabilized. Once stabilized, the top stabilized icon will be displayed then.

Note: In measurement mode, long press "SET" to switch between Conductivity / TDS / Salinity measurement mode.

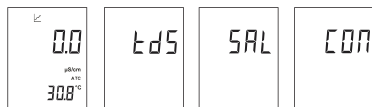

7. Calibration Mode

In measurement mode, press "CAL" to enter calibration mode. Prompting icons will be displayed on the screen.

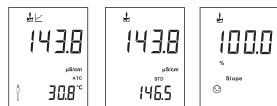

Clean the electrode with pure water. Dip the electrode into the standard solution, the stabilized icon will be displayed at the top of the screen. Press "ENT" to confirm. The standard value is at the bottom. You can adjust the value as standard by pressing "CAL" or "SET". Press "ENT" to confirm. The slope rate of the calibration will be displayed and automatically go back to the measurement mode. You can also press "⏻" to skip the calibration and back to the measurement mode. Long press "CAL" to check through the calibrated parameters, Press "CAL" and "SET" to check the Zero offset and the Slope.



-5-

8. Set up

In measurement mode, press "SET" to enter SET UP. Corresponding icons will be displayed. You can press "CAL" and "SET" to select the menu and then press "ENT" to confirm. Press "CAL" or "SET" to set up and confirm by press "ENT". You can also press "⏻" to back to measurement mode.

The Set up menu as follow:

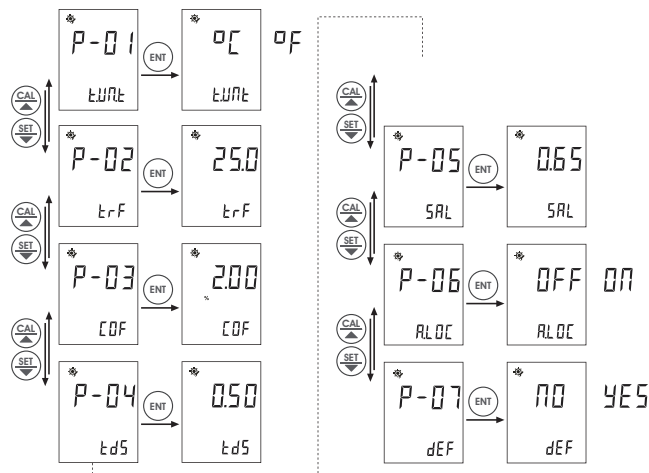

P01: Unit of the temperature: You can select between °C and °F.

P02: Temperature base: Range:15-35 °C

P03: Temperature compensation factor: Range:0.0-10.0%

P04: TDS factor

P05: Salinity factor

P06: Auto Lock. You can select "ON" or "OFF" to auto lock the data once stabilized.

P07: Factory defaults. You can select to revert to factory defaults.

-6-

9. Specification

Range	0.0 µS/cm (ppm) - 20.00 mS/cm (ppt)
Resolution	0.1 µS/cm (ppm) - 0.01 mS/cm (ppt)
Accuracy	±2% F.S.
Temp. Range	0 - 100.0 °C / 32 - 212 °F
Working Temperature	0 - 60.0 °C / 32 - 140 °F
Auto Temperature Compensation	0 - 60°C
Calibration	1 or 2 point auto calibrate (0% zero oxygen or 100% in air)
TDS Range	0.0 mg/L (ppm) - 20.00 g/L (ppt)
TDS Coefficient	0.40 - 1.00 Adjustable (Coefficient:0.5)
Salinity Range	0.0 mg/L (ppm) - 13.00 g/L (ppt)
Salinity Coefficient	0.65
Atmospheric Pressure Compensation	600 - 1100 mbar
Auto backlight off	1 minutes
Auto power off	5 minutes without key be pressed
Power	1x1.5V AAA battery
Dimensions	(H×W×D) 185×40×48 mm
Weight	95g
Protection	IP67

10. Package



Size: L*W*H 210*100*65mm
Weight: 350g

MCON tester body
CS3930 electrode
1.5VAAA battery

-7-

11. Error

When ERR occurs, you can check the electrode and the standard solution.

12. GENERAL INFORMATION

Warranty

CLEAN Instruments warrants this product to be free from significant deviations in material and workmanship for a period of one year from the date of purchase. If repair is necessary and has not been the result of abuse or misuse within the warranty period, please return to CLEAN Instruments and amendment will be made without any charge. CLEAN Instruments Customer Service Center will determine if product problem is due to deviations or customer abuse. Out of warranty products will be repaired on a charge basis.

Return Of Malfunction Instruments

Authorization must be obtained from CLEAN Instruments Customer Service Center to issue a RIR number before returning items for any reason. When applying for authorization, please include date requiring the reason of return. Instruments must be carefully packed to prevent damage in shipment and insured against possible damage or loss. CLEAN Instruments will not be responsible for any damage resulting from careless or insufficient packing.

Warning: Damage as a result of inadequate packaging is the User / distributor's responsibility.

Please follow the guidelines below before transporting.

Guidelines Or Returning Unit For Repair

Use the original packaging material if possible, when transporting back the unit for repair. Otherwise wrap it with bubble pack and use a corrugated box for better protection. Include a brief description of any faults suspected for the convenience of Customer Service Center, if possible. If there are any questions, feel free to contact our Customer Service Center or distributors.

-8-